



## Hoyt Phase Sequence Indicators

### Phase Sequence Indicators Contact Type

ST-850 .....	1
855 PR .....	2
855 PRA .....	2
855 PRB .....	2
ST-860 .....	3
862 PR .....	4
863 PR .....	5
865 PR .....	6
887 PR .....	7
888 PMR .....	8

### Phase Sequence Indicators Non-Contact Type

890 PR .....	9
895 PR .....	10

### Phase Rotation Testers

885 PR .....	11
4156 PR .....	12

### Phase Rotation Testers

4183 CP .....	13
---------------	----

## ST-850 Phase Sequence Indicator (Contact Type)

### Features

- Two functions in one unit: open phase and phase sequence detection.
- Lamps let you determine at-a-glance if phase is open.
- Large size alligator clips for easy clipping onto switch-boards terminals.
- Checks a wide range of 3-phase power sources.
- Special test leads length are available on request.
- Push button switch is designed to minimize damage due to negligence.

### Specifications

Voltage	90V-600V AC
Frequency response	50 / 60 Hz
Operating temperature & humidity	0°C ~ 40°C at 80% Max. relative humidity
Storage temperature & humidity	-10°C ~ 50°C at 90% Max. relative humidity
Cord	1.1m each of red(R), white(S) and black(T) cord
Dimensions	134(L) × 85(W) × 45(D)mm
Weight	Approx. 510g
Safety standard	IEC 1010 CAT II 600V

### Accessories

Instruction manual  
Soft pouch



# Phase Sequence Indicators

## 855 PR Phase Sequence Indicator (Contact Type)

CE



855 PR

### Features

- Two functions in one unit: open phase and phase sequence detection.
- Lamps let you determine at-a-glance if phase is open.
- Large size alligator clips for easy clipping onto switch-boards terminals.
- Checks a wide range of 3-phase power sources.
- Special test leads length are available on request.
- Push button switch is designed to minimize damage due to negligence.

### Specifications

Voltage	200V-600V AC
Frequency response	50 / 60 Hz
Operating temperature & humidity	0°C ~ 40°C at 80% Max. relative humidity
Storage temperature & humidity	-10°C ~ 50°C at 90% Max. relative humidity
Cord	1.1m each of red(R), white(S) and black(T) cord
Dimensions	134(L) × 85(W) × 45(D)mm
Weight	Approx. 530g
Safety standard	EN 61010-1 CAT IV 600V, EN 61326-1

CE



Fuse

855 PRA

### Accessories

- Instruction manual
- Soft pouch

CE



855 PRB

- Silicone wire 2m
- + Fuse
- + Alligator(AL-23 CA)

# Phase Sequence Indicators

## ST-860 Phase Sequence Indicator (Contact Type)

### Features

- Three functions in one unit: open phase, phase sequence and motor rotation indication.
- Large size alligator clips for easy clipping onto switch-boards terminals.
- Highly reliable.
- Identifies 3 phase sequence and open phase check.
- Ideal for installing conveyor lines, pump systems and interconnected drivers.

### Specifications

Input voltage	100-600V AC
Frequency range	45-70 Hz
Circuit structure	All electronic (not mechanical)
Power requirement	9V (6F22) × 1
Power consumption	Consumption current approx. 14mA of motor rotation field tester
AC power consumption	Approx. 7mA
Dimensions	150(L) × 72(W) × 35(D)mm
Weight (battery included)	Approx. 212g
Safety standard	EN 61010-1 CAT III 600V EN 61326-1

### Accessories

Instruction manual  
Test leads  
Soft pouch  
Battery



## 862 PR Phase Sequence Indicator (Contact Type)

IP24



CE



CAC-860 B

### Features

- Two functions in one unit: open phase and phase sequence detection.
- Neon light indicators.
- Large size alligator clips for easy clipping onto switch-boards terminals.
- Checks a wide range of 3-phase power sources.
- Ideal for installing conveyor lines, pump systems and interconnected drivers.
- Waterproof design, protection class : IP24.
- Special test leads length are available on request.

### Specifications

Input voltage	100-600V AC
Frequency range	45 - 70 Hz
Circuit structure	All electronic (not mechanical)
AC power consumption	Approx. 7mA
Dimensions	102(L) × 78(W) × 32.5(D)mm
Weight	
862 PR	115g
Test leads	97g
Total	212g
Safety standard	EN 61010-1 CAT III 600V CAT IV 300V EN 61326-1

### Accessories

- Instruction manual
- Test leads
- Soft pouch

## 863 PR Phase Sequence Indicator (Contact Type)



Lorem ipsum

### Features

- Two functions in one unit: open phase and phase sequence detection.
- Neon light indicators.
- Large size alligator clips for easy clipping onto switch-boards terminals.
- Allows you to check a wide range of 3-phase power sources.
- Special test leads length are available on request.

### Specifications

Input voltage	100-500V AC
Frequency range	45 - 70 Hz
Circuit structure	All electronic (not mechanical)
AC power consumption	Approx. 7mA
Dimensions	102(L) × 78(W) × 32.5(D)mm
Weight.	Approx. 228g
Safety standard	EN 61010-1 CAT III 600V EN 61326-1

CE



CAC-860 B

### Accessories

- Instruction manual
- Soft pouch



CE

## 865 PR Phase Sequence Indicator (Contact Type)

### Features

- The 865 PR is a detector with LEDs to show the detection better visible than neon.
- Three functions in one unit, including open phase, phase sequence and 3 phase motor rotation.
- Designed for checking a wider range of 3 phase power source from 100V to 600V.
- Indicates R.S.T LEDs which frequency range from 40Hz to 400Hz.
- Wide range detection of motor frequency range from 2Hz to 400Hz.
- Fixed magnets for convenient measurement.

### Specifications

Input voltage	100-600Vac
Frequency range	40Hz-400Hz
Operating temperature & humidity	0°C ~ 40°C Max. 80% R.H.
Storage temperature & humidity	-10°C ~ 50°C Max. 80% R.H.
Cable length	Approx. 60cm
Power source	9V (6F22) × 1
Dimensions	128(L) x 72(W) x 44(D)mm
Weight (battery included)	Approx. 220g
Safety standard	EN 61010-1 CAT III 600V EN 61326-1 EN 61557-1 EN 61557-7

### Live Wire check

State	Indication	
Detect Indications	Live phase	L1, L2, L3 LEDs illuminated
	Open phase	Corresponding LED not illuminated
	Correct phase sequence	CW LED illuminated
	Incorrect phase sequence	CCW LED illuminated

### Static Motor check

- Connect R, S, and T test leads to motor's L1, L2, and L3 terminals
- Rotate shaft at least ½ turn

State	Detect Indication	
Detect Indications	L1, L2, L3 direction	CW LED illuminated
	L2, L1, L3 direction	CCW LED illuminated

### Accessories

Instruction manual  
Test leads  
Soft pouch  
Battery

# Phase Sequence Indicators

## 887 PR Phase Sequence Indicator (Contact Type)

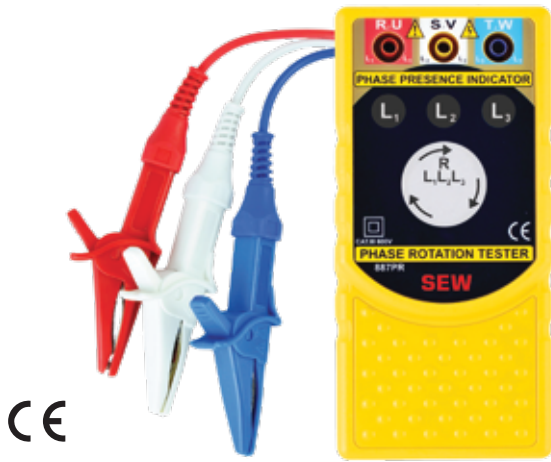

### Features

- Indicates phase rotation.
- Indicates phase presence.
- No battery required.
- Phase rotation phase presence indicated on large liquid crystal display.
- Small, rugged enclosure.
- Color coded test leads.
- Phase presence indication from as low as 40Vac to as high as 600Vac.
- Fused.
- Lightweight, robust and compact.

### Specifications

#### Determination of the Phase Presence

Nominal Voltage for Phase Presence Indication (the voltage required for the LCD L1, L2, L3 indicators to come on)	From 40Vac to 600Vac.
Frequency range	From 15Hz to 400Hz.

#### Determination of the Phases Rotary Field Direction:

Direction Indication by LCD Display (the voltage required to have the LCD Direction Arrows to indicate and the L1, L2, L3 or L3 L2 L1 indicators to show)	From 40 to 600Vac.
Frequency range	From 15 Hz to 400Hz

#### Protection

Over load	700V(between all terminals)
Over voltage	Class III - 700V towards ground
Fuses	2 × 0.5A/600V, 5 × 20mm, HBC, 600V Fast Blow

#### General

Current consumption	Max. 3mA
Material	Poly carbonate / ABS
Display	LCD
Operating temperature & humidity	1°C to + 55°C not in full sun!!!
Storage temperature & humidity	-20°C to + 70°C
Dimensions	150(L) × 72(W) × 33.8(D)mm
Weight (battery included)	Approx. 158.5g
Safety standard	EN 61010-1 CAT III 600V EN 61010-2-032

**3 Phases Presence and Rotation Indicator.**  
Does not need any battery as it derives its power from the system under test.

Can be utilized on a 3 Phases Powered System without having to worry about damage to the tester or the system.

Once connected to a 3 phase power system, it indicates the phase presence by showing its corresponding LCD symbol. It displays the rotation (clockwise or anti-clockwise) on the LCD.

This instrument represents the quickest and easiest way for verifying the presence and rotation of a 3 phase system.

You can, before connecting Supply to Load, and from the supply side; Quickly and easily verify the presence of the three Phases on a 3 Phase Power System.

Confirm the Phase Rotation on a Powered 3 Phase System.

#### 3 Phase Presence Indication circuit:

This circuit uses the LCD to indicate if a phase is present. The LCD indicators will light up when the voltage across any two phases are more than 40Vac.

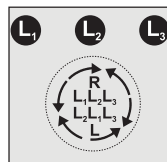
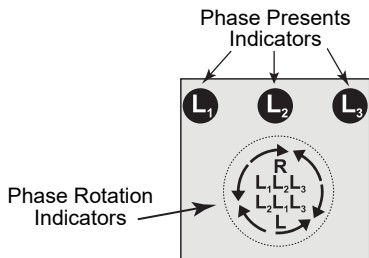

Everything is ON to show all segments

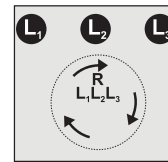

3 Phases Presence Rotating RIGHT L1L2L3

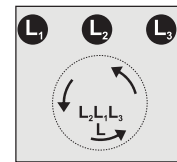

3 Phases Presence Rotating LEFT L1L2L3

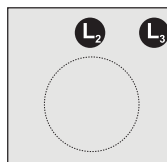

L1 Missing No Rotation Indication

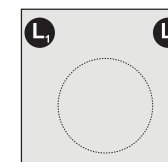

L2 Missing No Rotation Indication

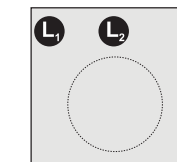

L3 Missing No Rotation Indication

#### 3 Phase sequence Rotation indicator circuit:

This circuit has also a LCD indication. The product does not require any battery as it takes its power from the circuit under test.



# Phase Sequence Indicators

## 888 PMR Phase Sequence Indicator (Contact Type)



CE

The 888 PMR is a 3-Phase Presence and Rotation Indicator combined with a 3-Phase Motor Rotation Tester. It can be utilized on either a powered system (the supply side) or an unpowered motor (the load side) with no damage to the tester.

When used on a powered system, the 888 PMR is a 3-Phase Presence and Rotation Indicator. It displays all three phases by illuminating the corresponding lamp. It also displays the rotation of the system (clockwise or anti-clockwise) on an LED.

When used on an unpowered motor, the 888 PMR is a 3-Phase Motor Rotation Tester. It is possible to determine the motor connections U, V, and W without a live circuit. This avoids damage to equipment (such as pumps) due to reversed motor rotation. The instrument also displays the rotation of the system (clockwise or anti-clockwise) on an LED.

The 888 PMR represents the quickest and easiest way of servicing, repairing and maintaining 3-phase powered systems and 3-phase rotating machinery

### Features

- Indicates phase rotation
- Indicates phase presence
- Indicates motor rotation/wiring
- Indicates battery status
- Phase rotation and motor rotation indications from as low as 1Vac
- Compact, lightweight, and rugged
- Color coded test leads
- Phase presence indication from as low as 100 Vac
- Very low power consumption
- Fuse protection
- Works from 2 Hz to 400 Hz Sine

### Specifications

Voltage and Frequency for Phase Presence Indication	From: 100Vac To: 600Vac Freq: 10-400Hz
-----------------------------------------------------	----------------------------------------------

Determination of Phase Rotation Field Direction	From: 1Vac To: 600Vac Freq: 2-400Hz
-------------------------------------------------	-------------------------------------------

Determination of Motor Connections (requires > 1/2 turn of the shaft)	From: 1Vac To: 600Vac Freq: 2-400Hz
-----------------------------------------------------------------------	-------------------------------------------

### General

Maximum Current Consumption	18mA
Over Voltage	CLASS III 600V
Over Load between all terminals	600V
Battery OK light illuminated	> 6.5 Vdc
Dimensions	153(L) × 72(W) × 35(D)mm
Weight (battery included)	Approx. 185g
Power source	9V (6F22) × 1
Safety standard	EN 61010-1 CAT III 600V

### Accessories

- Instruction manual
- Test leads
- Soft pouch
- Battery

This equipment can, before connecting Supply to Load:

<b>On the Supply Side (Powered System):</b>	Quickly verify the presence of the three Phases Confirm the Phase Rotation.
<b>On the Motor Side (Load):</b>	Confirm the Phase Rotation on of an unpowered Motor or Alternator. Confirm that each winding is connected to the terminals of the motor.

# Phase Sequence Indicators

## 890 PR Phase Sequence Indicator (Non-Contact Type)

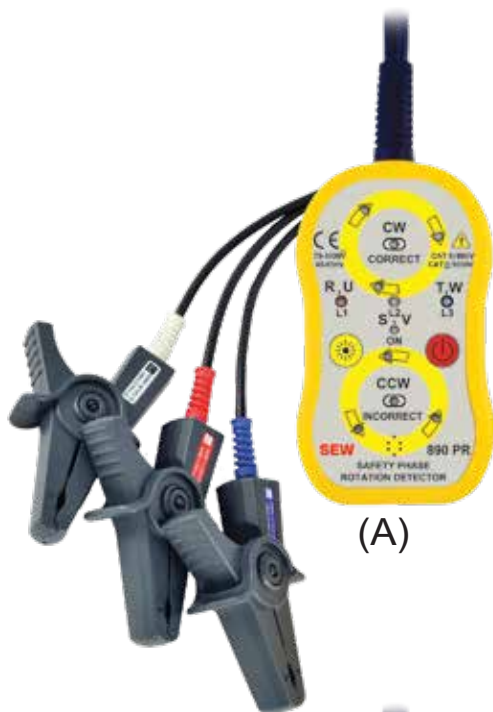

(A)

### Features

- Non-Contact phase sequence detector.
- Flashing LEDs and beeping buzzer indications of AC 3-phase sequence.
- Two functions in one unit: open phase and phase sequence detection.
- Convenient brightness switch to make the indication visible in dim areas or sunlight.
- Back cover magnet attaches the instrument to the AC distribution panel, offering easy measurement.
- Detects 3-Phase AC voltage from 70V to 1000V.
- Conductor size: 1~35mm.
- Detection frequency range from 45Hz to 65Hz.

### Specifications

Measurement principle	Static induction
Input voltage	70~1000Vac
Frequency range	45-65Hz
Auto-off	5 min. after power on without detection
Low battery warning	Power LED flashes at 4.6±0.1V or less

### General

Operating temperature & humidity	0°C ~ 40°C Max. 80% R.H.
Storage temperature & humidity	-10°C ~ 50°C Max. 80% R.H.
Cable length Approx.	800mm
Dimensions	118(L) × 69(W) × 38(D)mm
Weight (battery included)	Approx. 370g
Power source	1.5V (AA) × 4 Alkaline batteries
Safety standard	EN 61010-1 CAT III 1000V / CAT IV 600V EN 61326-1 EN 61557-1 EN 61557-7

### Live Wire Check

State	Indication
Live	Phase with L1, L2, L3, "ON" is live state
Missing line of earth line	LED doesn't light up for missing line of earth line
Earth line (Delta connection)	Phase with flashing LED is an earth phase
Positive phase	Green rotation LEDs flash in clockwise direction, and buzzer sounds intermittently. The circuit under test will have forward rotation.
Reversed phase	Red rotation LEDs flash in anticlockwise direction, and buzzer sounds continuously. The circuit under test will have reverse rotation.
Detect Indications	Live phase: L1, L2, L3 LEDs illuminated Open phase: Corresponding LED not illuminated Correct phase sequence: Green CW (clockwise) LED Incorrect phase sequence: Red CCW (counterclockwise)

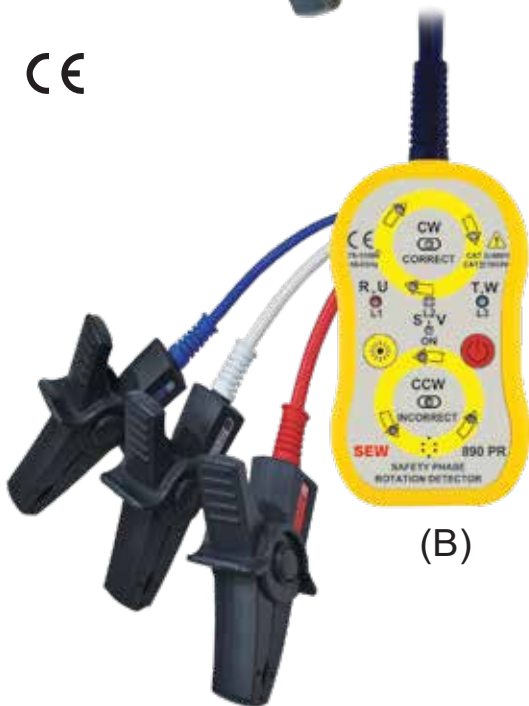

(B)

### Accessories

Instruction manual  
Test leads  
Soft pouch  
Battery

# Phase Sequence Indicators

## 895 PR Phase Sequence Indicator (Non-Contact Type)

### Features

- Non-contact detector clips; no metal contact points to provide greater safety
- Two functions in one unit: open phase and phase sequence detection
- Designed for checking a wider range of 3-phase power sources
- LED display lights with buzzer indicator
- Brightness button feature for better visibility in dimly lit areas or sunlight
- Magnetic mounting feature

### Specifications

Measurement principle	Static induction
Input voltage	75~1000Vac
Frequency range	45-65Hz
Auto-off	5 min. after power on without detection
Low battery warning	Power LED flashes at $7\pm 0.2V$ or less

### General

Operating temperature & humidity	0°C ~ 40°C Max. 80% R.H.
Storage temperature & humidity	-10°C ~ 50°C Max. 80% R.H.
Cable length Approx.	800mm
Dimensions	128(L) × 72(W) × 44(D)mm
Weight (battery included)	Approx. 380g
Power source	9V (6LF22) × 1
Safety standard	EN 61010-1 CAT III 1000V / CAT IV 600V EN 61326-1 EN 61557-1 EN 61557-7

### Live Wire Check

State	Indication
Live	Phase with L1, L2, L3, "ON" is live state
Missing line of earth line	LED doesn't light up for missing line of earth line
Earth line (Delta connection)	Phase with flashing LED is an earth phase
Positive phase	Green rotation LEDs flash in clockwise direction, and buzzer sounds intermittently. The circuit under test will have forward rotation.
Reversed phase	Red rotation LEDs flash in anticlockwise direction, and buzzer sounds continuously. The circuit under test will have reverse rotation.
Detect Indications	Live phase: L1, L2, L3 LEDs illuminated Open phase: Corresponding LED not illuminated Correct phase sequence: Green CW (clockwise) LED Incorrect phase sequence: Red CCW (counterclockwise)

CE



### Accessories

Instruction manual  
Soft pouch  
Battery

# Phase Sequence Indicators

## 885 PR Phase rotation tester with voltmeter



### Features

- 3 functions in one unit: Phase Rotation, Phase Presence, Voltmeter
- LCD contact type Phase Rotation Tester
- Large LCD to show phase rotation and phase presence
- Check a wide range of three phase power sources
- Voltage range for phase rotation test: 75~600V AC
- Frequency range: 40~400Hz
- 6000-count voltmeter
- Auto ranging Voltmeter AC/DC
- Data hold function
- Auto power off
- Convenient stand for viewing
- Easy to use

### Specifications

Voltage Range	75~600Vac
Frequency Range	40~400Hz
Circuit Structure	All electronic
Dimension	165(L) x 82(W) x 45(D)mm
Weight (battery included)	Approx. 245g
Power Source	1.5V (AAA) battery x 2
Display	LCD
Safety Standard	EN 61010-1 CAT III 600V EN 61010-2-033 EN 61326-1

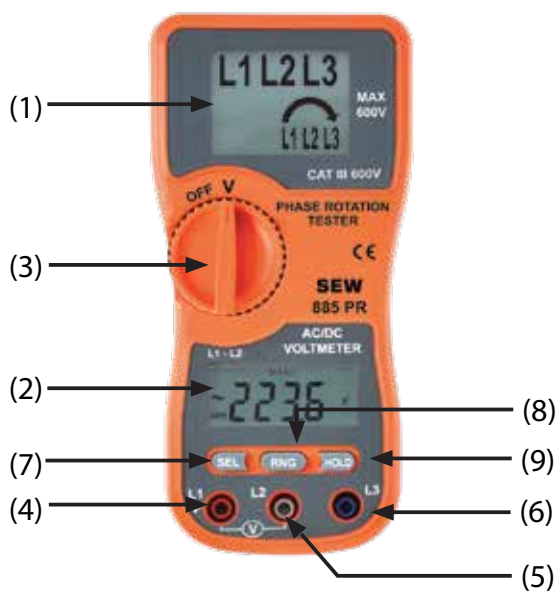

- |                            |                 |
|----------------------------|-----------------|
| (1) LCD for Phase Rotation | (6) L3 Terminal |
| (2) LCD for Voltmeter      | (7) SEL Button  |
| (3) Rotary Switch          | (8) RNG Button  |
| (4) L1 Terminal            | (9) HOLD Button |
| (5) L2 Terminal            |                 |

### Voltmeter ACV

Range	Resolution	Accuracy
600mV	0.1mV	
6V	1mV	±(2.3% rdg+5dgt)
60V	10mV	
600V	0.1V	

### Voltmeter DCV

Range	Resolution	Accuracy
600mV	0.1mV	
6V	1mV	±(0.8% rdg+3dgt)
60V	10mV	
600V	0.1V	

### Accessories

- Instruction manual
- Batteries
- Test leads



# Phase Sequence Indicators

## 4156 PR Phase and Motor Rotation Tester

### Operation

#### ● Motor Rotation Test

Set the rotary switch to Motor position. Use the yellow terminals on the left of the meter. Connect the test leads to the motor in any order. Operate the ZERO adjustment to set the meter pointer at the center of the scale. Manually turn the motor shaft slightly in the desired operating direction (clockwise or counter-clockwise). Observe the meter. The meter will deflect (kick) in one direction then in the opposite direction. The first direction is significant. Ignore the second or opposite direction. The first direction is the correct direction for users to identify the motor rotation.

#### ● Phase Rotation Test

Set the rotary switch to Phase Rotation position. Use the red terminals on the right of the meter. Connect the test leads to the three terminals of the line system in any order. Observe the meter. If the pointer deflects to the right, that means the Rotation is clockwise. The phase sequence is R, S and T in order of the power source terminals where the test leads are connected. If the pointer deflects to the left, that means the Rotation is counter-clockwise.

#### ● Transformer Polarity-Single Phase

Set the rotary switch to OFF position. Connect test leads to the yellow terminals on the left of the panel. Connect two adjacent high and low voltage transformer terminals using a suitable jumper. Connect the L3 terminal to one of the terminals where the jumper connected. Connect the L2 terminal to the remaining high voltage terminal. Connect the L1 terminal to the remaining low voltage terminal. Set the rotary switch to TRANS position. Press the Momentary Test push button and release. Observe the meter on release. Deflection of the meter indicates transformer polarity. Read either Subtractive to the right, or Additive to the left. If sensitivity is not adequate on low ratio transformers, switch to MOTOR position without changing test leads, operate Zero ADJ. knob to set pointer at center, then test As above.

#### ● Continuity Check

Set the rotary switch to MOTOR (CONT.) Position. Use the L1 and the L2 terminal for continuity checking. At first, connect the two test leads together. Then operate Zero ADJ. knob until the meter reads zero on the scale plate. Connect the two test leads to the resistance we want to measure. Then read the value on the meter.

### Specifications

Measuring ranges	0~200kΩ
Test leads AL-34 length	50cm
Dimensions	250(L) × 190(W) × 110(D)mm
Weight (battery included)	Approx. 1280g
Power source	1.5V (AA) × 2
Safety standard	EN 61010-1 EN 61326-1



The 4156 PR is used to identify the leads of a disconnected motor so that when the motor is in true phase sequence, it will run in the desired direction.

The identification process is necessary before a motor can be connected. The tester is also used to identify true phase sequence of energized AC power lines up to 600 AC volts. The other functions of the 4156 PR include the determination of transformer polarity and testing of circuit continuity.

The three red terminals on the right side (R,S,T) are used to be connected to energized AC power systems up to 600 volts. The other three yellow terminals on the left side (L1, L2, L3) are for connection to de-energized equipment. Do not connect to Live Voltage!

The Momentary Test push-button is used to identify transformer polarity. Deflection of the rotation pointer indicates transformer polarity. Read either Subtractive on the right, or Additive to the left. The Zero Adjustment knob is used to check continuity.

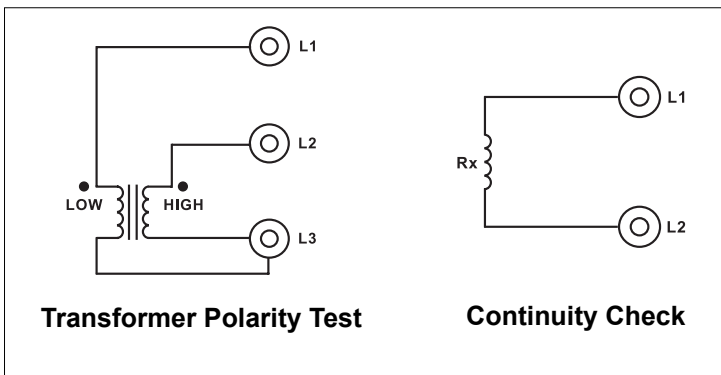

## 4183 CP Cable Phasing Meter



### Features

- Safely operates at low voltage
- Measures system voltage.
- Measures capacitance of test point if system voltage is known.
- Checks phase rotation of cables.
- Phases out cables.
- Rugged - comes with portable case.
- Operates from potential test point of elbow connectors.
- Battery operated.

The 4183 CP is a Cable Phasing Meter that offers a quick method of measuring voltage and determining phase rotation of underground distribution systems using the capacitive test point of elbow connectors.

Most manufacturers of high voltage cable terminations incorporate capacitive test points in their elbow connectors.

These test points are designed for measuring purposes.

This instrument is battery powered and is supplied with a ground and two measuring leads.

CE

### Specifications

Voltage ranges	0~16kV / 0~32kV
Accuracy	±8% (exclusive of tap capacitance variations)
Tap capacitance setting	0.4 to 3.0 pF continuous per channel
Frequency	50 or 60 Hz
Dimensions	250(L) × 190(W) × 110(D)mm
Weight	Approx. 1420g (battery included)
Power source	1.5V (AA) × 4
Safety standard	EN 61326-1



Test leads

### Accessories

- Instruction manual
- Test leads
- Shoulder belt
- Batteries