



685 VU Series

Analog VU Panel Meters



2.5"
685 VU

■ Please specify when ordering as 685-1, 685-2, 685-3.

The VU meters have become the universal standard level indicator for practically all audio frequency transmission systems. VU meters are for the measurement of sound or noise levels - including broadcast monitoring, use with public address of communication systems, and in all instances where volume level measurements are to be made. They are also being used for the measurement of noise level and other audio frequency energy where established dynamic characteristics of the instrument give a common result for measurements taken in different laboratories.

Specifications

Accuracy:	±2% full scale value.
Resistance:	Designed to read zero VU or 100% with 1.228 volts applied to the instrument and the 3600 ohm series resistance; this represents 4 DB above 1 milliwatt in 600 ohms.
Dials:	100 degree arc, black lettering on white or buff background.
Scale:	Type "A" Scale reads "-20 to +3" in type on the top of the arc, with "0-100" on the bottom of the arc in type. Type "B" Scale reads "0-100" in type on the top of the arc, with "-20 to +3" in type on the bottom of the arc.
Pointer:	Knife Edge.
Movement:	Pivot and Jewel.
Mounting:	Panel Mount with Bezel (Horizontal/Vertical).
Case:	Lexan.
Operating Temperature:	32°F to 104°F (0°C to 40°C).
Storage Temperature:	-4°F to 131°F (-20°C to 55°C).
Relative Humidity:	20% to 80%RH (Nominal Use).
Meter Approvals:	ANSI C39.1.
Origin:	Made in USA

Bezel Mount Kit
for the 685-1 (Single), 685-2 (Dual Stack),
685-3 (Triple Stack)
has a cold rolled steel finish in black.



Dimensions

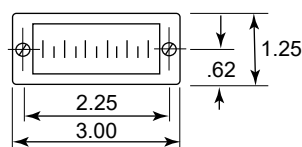
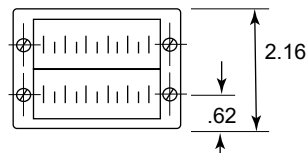
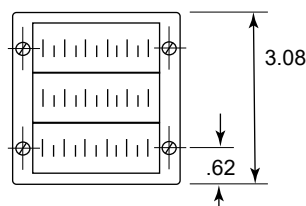
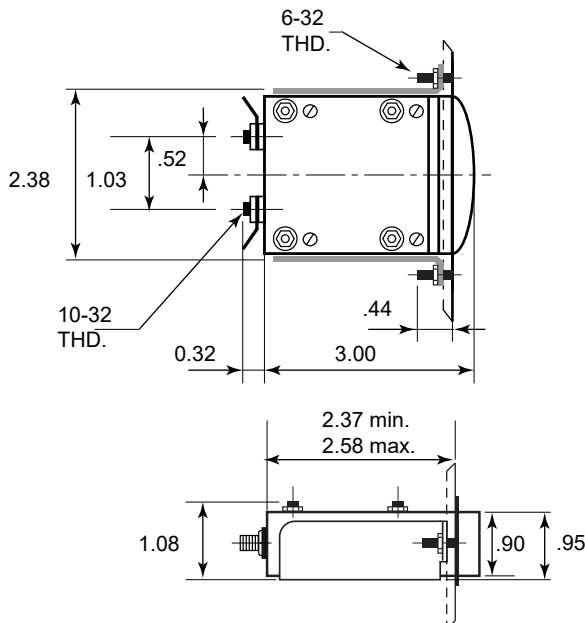

Panel Cutout

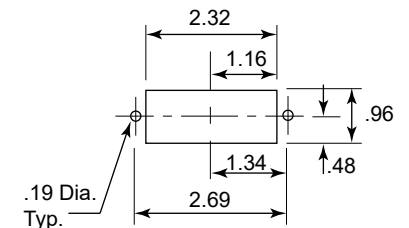
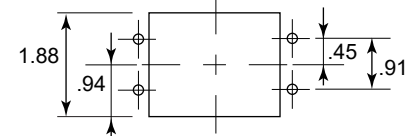
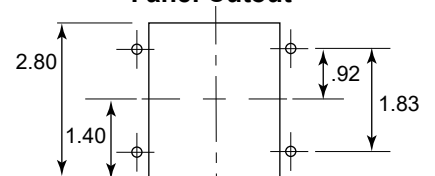

Hoyt Electrical Instrument Works, Inc.

23 Meter Street
Penacook, NH 03303

Phone: (800) 258-3652
Fax: (603) 753-9592
Email: sales@hoytmeter.com

www.hoytmeter.com