

# Digital Variable High Voltage Insulation Tester

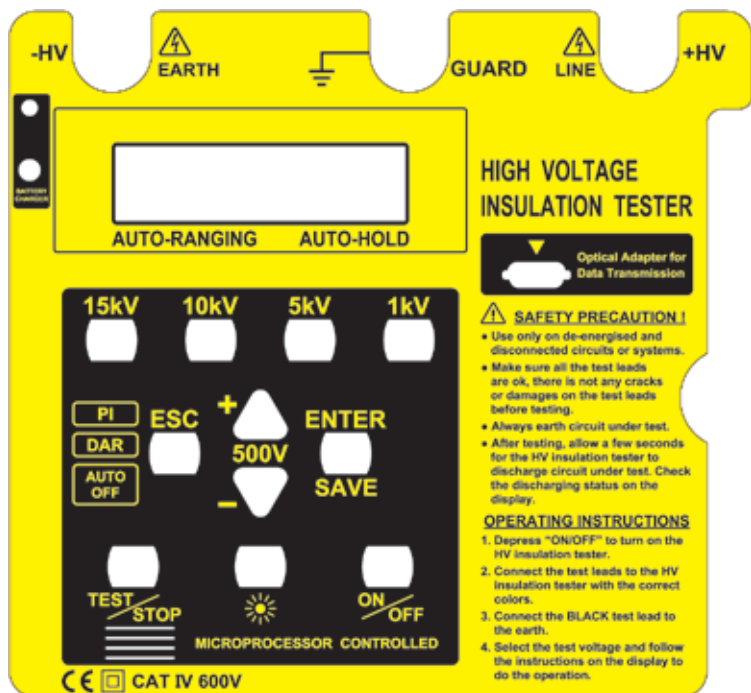

## INSTRUCTION MANUAL

Index	Page
1. Safety Precautions.....	1
2. Overview.....	2
3. Features.....	3
4. Specifications.....	4
5. Connections.....	5
6. Instrument layout.....	6
7. Measuring procedure.....	7
8. Charge.....	14
9. Maintenance & repair.....	14
10. Interface connection and operation.....	15

# 1. Safety Precautions

Electricity can cause severe injuries even with low voltages or currents. Therefore it is extremely important that you read the following information before using your high voltage insulation tester.

- a. This Instrument must only be used and operated by a competent trained person and in strict accordance with the instructions. we will not accept liability for any damage or injury caused by misuse or non compliance with instructions and safety procedures.
- b. This instrument must not be used on live circuits. Ensure all circuits are de-energised before testing. see paragraph for details of built-in warning features should your high voltage insulation tester be connected to a live system.
- c. Always inspect your high voltage insulation tester and test leads before use for any sign of abnormality or damage. If any abnormal conditions exist (broken test leads, cracked case, display faulty etc...) do not attempt to take any measurement or use the tester. Return your high voltage insulation tester to your nearest distributor for service.
- d. Your high voltage insulation tester has been designed with your safety in mind. However, no design can completely protect against incorrect use. Electrical circuits can be dangerous and / or lethal when a lack of caution or poor safety practice is used.
- e. Pay attention to cautions and warnings which will inform you of potentially dangerous procedures.
- f. Your high voltage insulation tester has a live circuit warning beeper. If it is connected to a live circuit, a rapid pulsating bleep will be heard. DO NOT proceed to test and immediately disconnect the instrument from the circuit. In addition your tester will display the warning message.

g. Rated environmental conditions:

- (1) Indoor use.
- (2) Installation Category IV.
- (3) Pollution Degree 2.
- (4) Altitude up to 2000 meters.
- (5) Relative humidity 80% max.
- (6) Ambient temperature 0°C~40°C.

h. Observe the international Electrical Symbols listed below:



Meter is protected throughout by double insulation or reinforced insulation.



Warning ! Risk of electric shock.



Caution ! Refer to this manual before using the meter.



Guard

## 2. Overview

This is a variable high voltage insulation tester from 500V to 15kV in 500V steps.

The is menu driven and uses Dynamic Current Auto ranging technology. It has a Bar-Graph which displays the voltage stressing the insulation while the test is in progress and the voltage decay during the automatic discharge of the tested circuit.

The top line of the display shows the elapsed time at the start of the test. Digital readout of the total time will remain displayed even after testing has ceased.

A 4-digit display (2000 counts) is showing the actual insulation resistance. This instrument displays a voltage warning and sounds when AC or DC is present before injecting the test voltage.

### 3. Features

- Microprocessor controlled.
- 2 Lines x 16 characters, large intelligent LCD module.
- 30 insulation test voltages :
  - 500V, 1kV, 1.5kV, 2kV, 2.5kV, 3kV,
  - 3.5kV, 4kV, 4.5kV, 5kV, 5.5kV, 6kV,
  - 6.5kV, 7kV, 7.5kV, 8kV, 8.5kV, 9kV,
  - 9.5kV, 10kV, 10.5kV, 11kV, 11.5kV, 12kV,
  - 12.5kV, 13kV, 13.5kV, 14kV, 14.5kV, 15kV
- AC/DC Voltmeter.
- PI (Polarization Index) indication.
- DAR (Dielectric Absorption ratio) indication.
- Auto-ranging on all insulation ranges.
- Backlight function.
- Bargraph indicates test voltage, rise and decay can be observed.
- Menu driven.
- Visual and audible warning if external voltage is present.  
( $\geq 30\text{Vac}$  or  $\geq 30\text{Vdc}$ )
- Short-circuit current up to 5mA
- Auto-hold function to freeze the reading.
- Overload protection.
- Adjustment for testing time (duration) : 1~30 minutes.
- Calendar.
- Indication memory for data storage.
- Optical USB to RS-232 data transmission.
- Auto-off.
- 200 measurement results can be saved in the memory and recalled on the display.

## 4. Specifications

Test Voltage	From 500Vdc to 15kVdc Adjustable in 500V steps
Preset buttons	1kV, 5kV, 10kV, 15kV
Measuring ranges	70GΩ/0.5kV 70GΩ at 0.5kV~2TΩ at 15kV
Accuracy	±(5%rdg+5dgt)
Resolution	2GΩ : 0.001GΩ 20GΩ : 0.01GΩ 200GΩ : 0.1GΩ 2TΩ : 1GΩ
Short circuit current	up to 5mA
PI (Polarization Index)	√
DAR (Dielectric Absorption Ratio)	√
Voltmeter	ACV : 0~600V DCV : 0~600V Accuracy : ±(2.0%rdg+3dgt) Resolution : 1V
Power source	Rechargeable battery
AC Adapter	Input : 100-240V~,0.4A ,50-60Hz Output : 24V 0.62A
Dimensions	430(L) x 324(W) x 127(D)mm
Weight	Approx : 5kg
Accessories	Instruction manual Test leads Data transmission cable Compact disk (CD) for PC interface Charger Alligator clip Test report

## 5. Connections

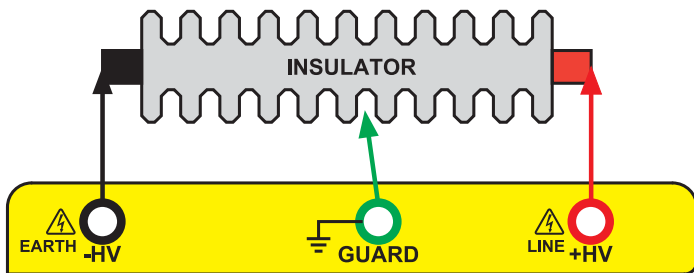

### FIRST MEASUREMENT

MEASURE WITHOUT THE GUARD TO TAKE EVERYTHING INTO ACCOUNT AND FIND OUT IF NEED CLEANING.

### **DIRTY ELECTRICAL EQUIVALENT INSULATOR CIRCUIT DIRTY INSULATOR**

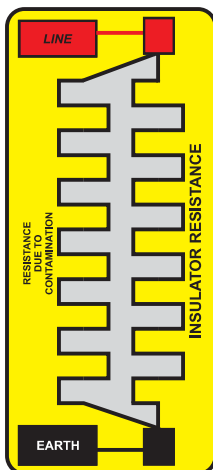
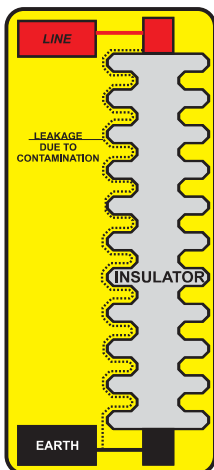

RESISTANCE DUE TO CONTAMINATION CAN BE VERY LOW AND LOWER THE TOTAL RESISTANCE.  
CLEANING PERIODICALLY CAN ALSO REDUCE SYSTEM POWER CONSUMPTION.

### SECOND MEASUREMENT

MEASURE WITH THE GUARD TO ENSURE INSULATOR IS CORRECT.

### **TYPICAL TEST**

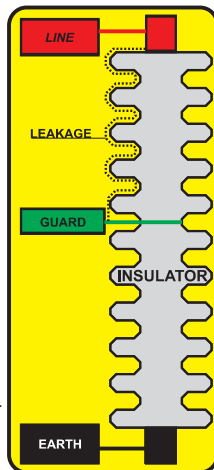

## 6. Instrument layout

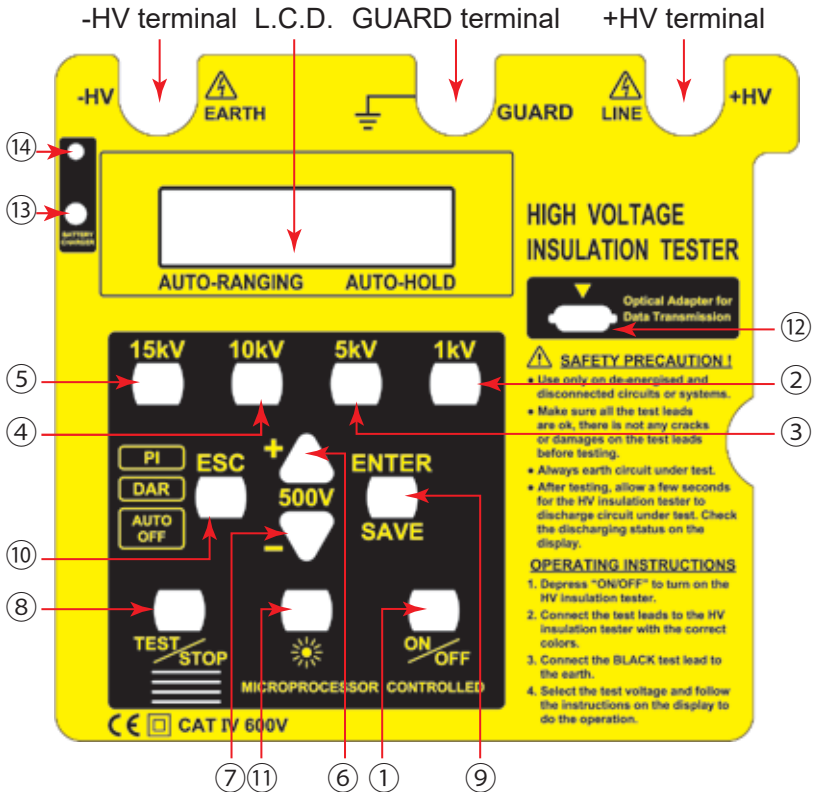

- |  |   |
|--|---|
| ① Power ON/OFF button                                | ⑦ To subtract (-500V) button to the selected test voltage |
| ② Insulation resistance test at 1kV button           | ⑧ TEST/STOP button  |
| ③ Insulation resistance test at 5kV button           | ⑨ ENTER & SAVE button                                     |
| ④ Insulation resistance test at 10kV button          | ⑩ ESC button  |
| ⑤ Insulation resistance test at 15kV button          | ⑪ BACKLIT button  |
| ⑥ To add (+500V) button to the selected test voltage | ⑫ Connection socket for data transmission                 |
|  | ⑬ Battery-charge socket                                   |
|  | ⑭ Charge indicator  |



## 7. Measuring procedure

This tester provide one main and five minor functions:

Main Function: insulation resistance test.

Minor functions:           Function 1 – Voltage measurement,  
                                  Function 2 – Date/time adjustment,  
                                  Function 3 – Measurement time setting,  
                                  Function 4 – Display data stored,  
                                  Function 5 – Delete data stored.

### (A) Insulation resistance measurement test (main function)



Note:

1. Before test performed, be sure that no voltage is made on the specimen. If voltage exists therein, remove the power supplied.
2. To secure operator's safety, check if there is any damage on the tester or test cable.
3. During the test, do not touch the metal on the specimen surface or test cable.
4. Wear insulation gloves and rubber shoes while operating this high-voltage measuring instrument.

(a) Checks before test is performed:

Press the power switch and check if power supply is sufficient? If insufficient, "Low Battery" will be displayed on the LCD display. Charge the battery before making measurement.

(b) Measuring procedure:

1. Connect specimen by test cable.

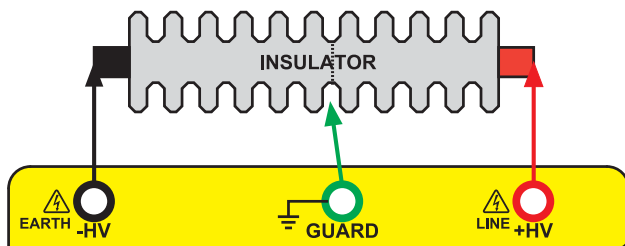

2. Press ① (ON/OFF) button.



```
2014-02-06
09:36:28
```

(Main page)

3. Select test voltage:

(1) Select one from 1kV, 5kV, 10kV or 15kV, press (② , ③, ④ or ⑤) respectively.

(2) To select voltage other than the four indicated, press anyone among ②, ③, ④, ⑤ , then, press ⑥ (voltadd) or ⑦ (volt-reduce) till the required voltage is reached.

4. Be sure that the cable connecting the specimen and Tester is correct. Then, press ⑧ (TEST/STOP); LCD displays as below:



```
Make sure the
Line Connected.
```

5. Then, press ⑧ (TEST/STOP).



Note:

(1) During test process, if there is a exterior voltage (above AC30V or DC30V) exerted, beeper activates in response; and LCD displays the warning picture as shown in below:



```
Voltage > 30V
ESC to Leave.
```

Now, test cannot be performed.

To go on the test it should remove the exterior voltage.

(2) While test is running, beeper activates to remind operator that test is underway.

(3) After the set test time is due (see Function 3: the test time setting), test stops and system will automatically lock down the test value.

(4) To read the test value on the LCD display, press the ⑪ BACKLIT button (☼).

6. Read the test value from LCD display



7. To store the data, press ⑨(ENTER/SAVE); LCD displays the picture shown in below:



## (B) Measure voltage (Voltage Meter) – Function 1

1. Press ① (ON/OFF) button.

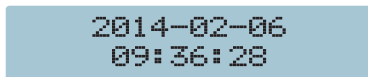

(Main page)

2. Press ⑥ value-add "+" or ⑦ value-reduce "-"; LCD displays the picture shown in below:



3. Press ⑨(ENTER/SAVE) to perform measurement; LCD displays the picture shown in below:

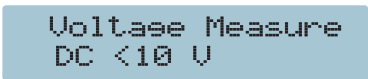

4. Read the data measured from LCD display.

5. Press ⑧ (TEST/STOP); then press ⑨ (ENTER) to save the data and lock the reading; LCD displays the picture shown in below:

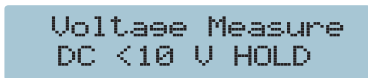

6. Press ⑩ (ESC) to return back to the former screen.

7. Then, press ⑩ (ESC) to return back to the main page.



Note:

SAVE cannot be applied during voltage measurement process.

## (C) Date/time adjustment (RTC Adjustment) – Function 2

1. Press ① (ON/OFF) button.



2014-02-06  
09:36:28

(Main page)

2. Press ⑥ (value-add) "+" for 2 times; LCD display the following pictures respectively:



Function 2  
RTC Adjustment

3. Press ⑨ (ENTER/SAVE) button.

4. Press ⑥ (value-add) "+" or ⑦ (value-reduce) "-" till the correct voltage is reached. Press ⑧ (TEST/STOP) to switch to next time unit and go on the required adjustment.

5. After all adjustments are complete, press ⑨ (ENTER/SAVE) to confirm and save the data measured.



Note:

if time unit (year, month, day, hour, minute or second) needs not to be adjusted, press ⑧ (TEST/STOP) to skip it.

6. Press ⑩ (ESC) to return back to the main page.

### (D) Measurement time setting (Test Timer) – Function 3

1. Press ① (ON/OFF) button.



2014-02-06  
09:36:28

(Main page)

2. Press ⑥ (value-add) "+" for 3 times; LCD display the following pictures respectively:



Function 3  
Test Timer

3. Press ⑨ (ENTER/SAVE), LCD displays the picture shown in below:

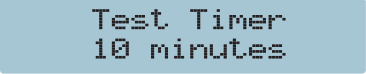

Test Timer  
10 minutes

4. Press ⑥ value-add "+" or ⑦ value-reduce "-" to set the test time.

5. After setting is complete, press ⑨ (ENTER/SAVE) to confirm & save the data measured.

6. Press ⑩ (ESC) to return back to the main page.

## (E) Display the data stored (LDG Display) – Function 4

1. Press ① (ON/OFF) button.



```
2014-02-06
09:36:28
```

(Main page)

2. Press ⑥ (value-add) "+" for 4 times; LCD display the following pictures respectively:



```
Function 4
LOG Display
```

3. Press ⑨ (ENTER/SAVE), LCD displays the picture shown in below:



```
001 (15.0KV)
>2000GΩ 00:22
```

4. Press ⑥ value-add "+" or ⑦ value-reduce "-" to select the required data value. If no data available, LCD displays the picture shown in below:



```
No Record.
```

5. Press ⑨ (ENTER/SAVE) to query the subpage of data.

6. After the query is over, press ⑩ (ESC) twice to go back the main page.

## (F) Clear/erase the display of data stored (LDG Clear) – Function 5

1. Press ① (ON/OFF) button.

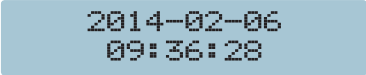

2014-02-06  
09:36:28

(Main page)

2. Press ⑥ (value-add) "+" for 5 times; LCD display the following pictures respectively:



Function 5  
LOG Clear

3. Press ⑨ (ENTER/SAVE) to inquire whether to clear up the data or not; LCD displays the picture shown in below:



Are You Sure?  
Enter to Clear.

Erase – press ⑨ (ENTER/SAVE). LCD displays the picture shown in below:



Clear Completely

Not erase – press ⑩ (ESC) to go back to the main page

## (G) Introduction of other functions

1. Dielectric absorption ratio (DAR):

Ratio of insulation resistance between 1-min and 30-sec

$$\text{DAR} : \frac{\text{1-min insulation resistance}}{\text{30-sec insulation resistance}}$$

2. Polarization index (PI):

Ratio of insulation resistance between 10-min and 1-min

$$\text{PI} : \frac{\text{10-min insulation resistance}}{\text{1-min insulation resistance}}$$

Lower insulation resistance tested takes longer test time, which would deteriorate the specimen. Thus, higher DAR or PI (as close to 1) would create better insulation grade of specimen.



Operation:

During the test run, wait for one minute, DAR will be displayed automatically; wait for 10 minutes, PI will be displayed automatically.

3. AUTO OFF:

System will shutdown automatically after 3 minutes without operation

## 8. Charge

(A) Timing:

After "Low Battery" is displayed on LCD display, perform battery charge; LCD displays the picture shown in below:



Low Battery

(B) Process:

1. Plug one end of charger into the battery plug-in socket (Fig ⑬); and the other end into the ACV power socket.

2. If ACV plug socket is energized, the charge indicator (Fig ⑭) is lit on indicating that charge is underway.

If the ACV plug socket isn't energized, remove to another power-energized one making power charge.

3. After the voltage reaches 16.5V, charge process is complete. (It can be observed on LCD display.)



No measurement can be performed during the charging process.

## 9. Maintenance & repair

(A) To avoid and electric-shock or device damage, do not wet inner part of the tester.

(B) Avoid the tester from being dropped down that would damage or disconnect devices apart.

(C) Wipe the tester surface with soft, dry cloth and mild detergent. Prohibit from using sand paper or solvent.



Note:

1. This tester is HV operated; user should not open the outer casing. If any damage occurs, take the tester back to manufacturer for repair.

2. If the tester isn't under operation for a long period, charge it at least once per month as to protect the battery from being deteriorated



## 10. Interface connection and operation

### (A) Insulation Tester Installation Steps:

1. This program will install Insulation Tester on your computer automatically.



2. Click the "Next" key to set.

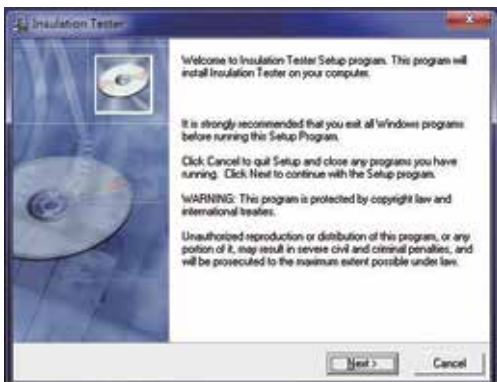

3. If you want to install a different folder, click Browse, and select another folder.

If it's not necessary, click the "Next" key.



4. Click the “Next” key.



5. It will show the information of all files are Installing to your personal computer.

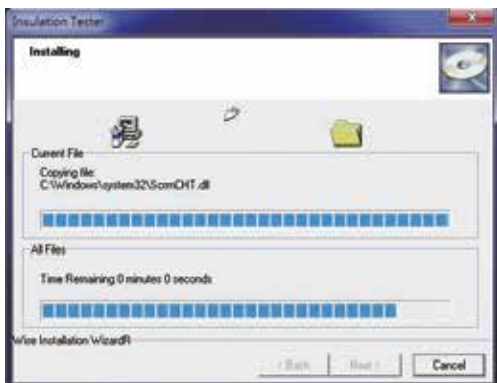

6. It will show the information of Insulation tester has been successfully installed and then click “Finish” key.

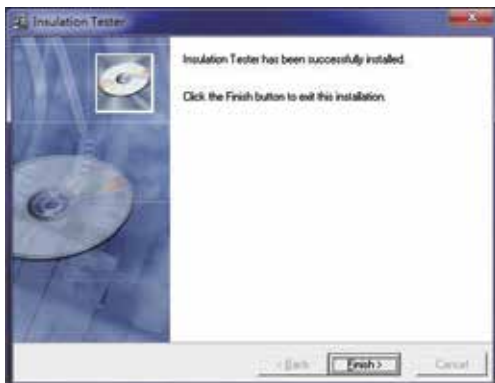

(Note: If your personal computer system is Windows 7, it will indicate the driver automatically. It's necessary to install the driver if your computer system is not windows 7, then the driver is in the compact disk (CD). The directory is “ E:USB DRIVER/CDM 2.08.24 WHQL Certified x 86-32 bit”.)

## (B) Windows Comm Port setting:

1. Plug data transmission cable into your personal computer USB port.
2. On your windows, click the “  ” key and find the “Control Panel” Application.

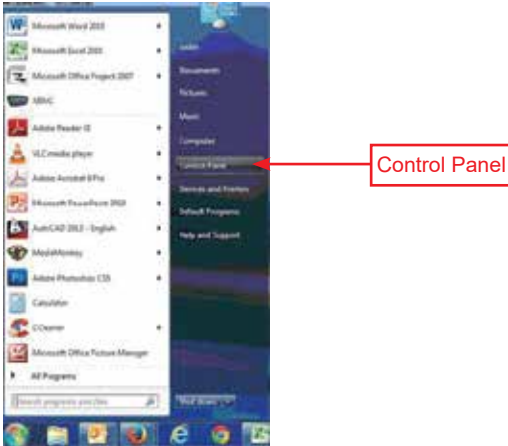

3. On the Control Panel Application, find the “Hardware and Sound” Application.

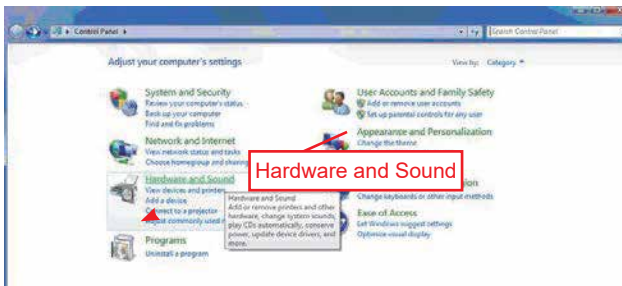

4. On the Hardware and Sound Application, find “Device Manager” Application.



5. On the Device Manger Application, click right button of the mouse and find “Universal Serial Bus Controllers”

6. On the Universal Serial Bus Controllers, Find the USB Serial Port (COM 3)

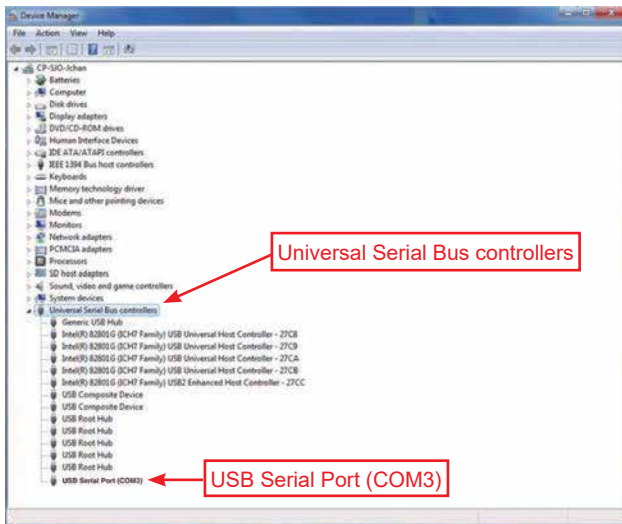

(Note: USB Serial Port will indicate different “COM” automatically)

### (C) Insulation Tester Software Comm Port setting:

1. Connect data transmission cable to the Insulation Tester.
2. Click the icon of the “Insulation Tester” on your desktop of your personal computer.



3. On the Insulation Tester Windows, select the correct “Comm Port” and click the RS 232 connection button

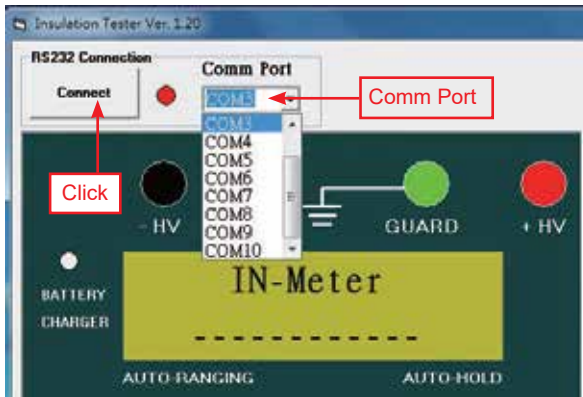

### (D) Insulation Tester Interface:

① RS 232 Connection.

② Main operation interface.

③ Memory saving and downloading interface.

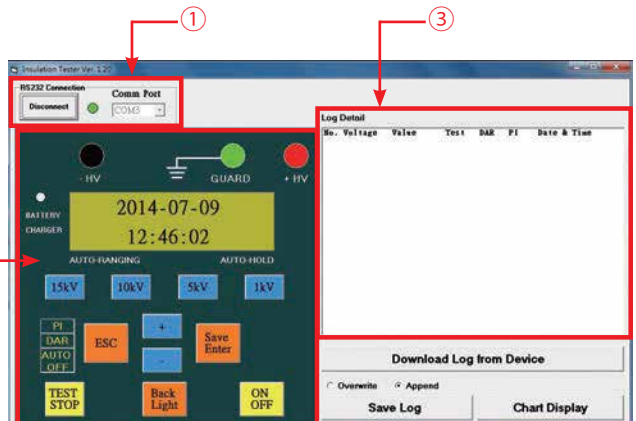

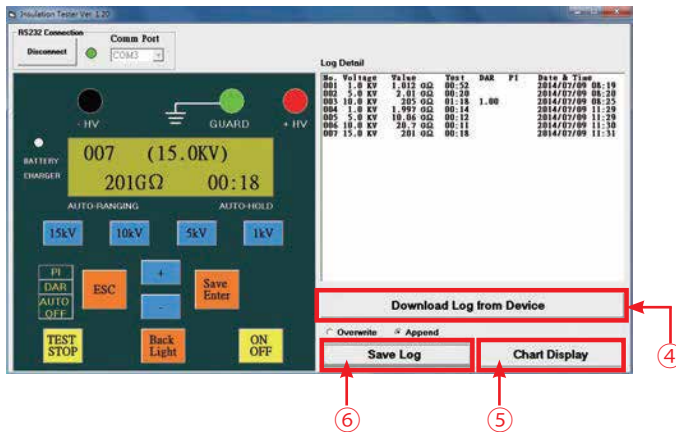

- ④ Click the "Download Log from Device" key to download the current data and statistics.
- ⑤ Click the "Chart Display" key to see the chart, picture shown in below:

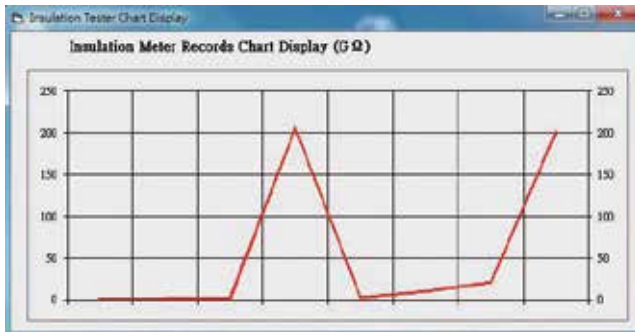

- ⑥ Click the "Save Log" key to the file, picture shown in below

ICO-20140709 - Note Pad

No.	Voltage	Value	Test	DAR	PI	Date & Time
001	1.0 KV	1.012 GΩ	00:52			2014/07/09 08:19
002	5.0 KV	2.01 GΩ	00:20			2014/07/09 08:20
003	10.0 KV	205 GΩ	01:18	1.00		2014/07/09 08:25
004	1.0 KV	1.997 GΩ	00:14			2014/07/09 11:29
005	5.0 KV	10.06 GΩ	00:12			2014/07/09 11:29
006	10.0 KV	20.7 GΩ	00:11			2014/07/09 11:30
007	15.0 KV	201 GΩ	00:18			2014/07/09 11:31

